

Air King[®]

Ventilation Products

SPECIFICATIONS
FRAK90
EXHAUST FANS

- **Grill**
Cold rolled steel, powder coated white.
- **Blower Wheel**
One piece polymeric centrifugal blower wheel, 5.22" diameter, 2.90" wide, with 30 paddles.
- **Motor**
Heavy duty, permanently split capacitor, 4 pole motor, life time lubrication, thermally protected. Rated 120 volts, 0.3 amps.
Contractor Pack (Motor/BladeGrill) Model: FAK90T*
- **Fan Housing**
24 gauge galvanized steel housing, dimensions 10³/₄" x 9¹/₄" x 7⁷/₈".
Contractor Pack Model: AKFH2*
- **Duct Collar**
Metal collar for 4" duct connection, comes complete with built in back draft damper.
- **Ventilating Area**
For rooms up to 115 sq. ft.
- **Unit Mounting**
FRAK90 is centered between joists (with 16" centers) using hanging brackets. The housing will mount through drywall thickness up to ³/₄", with a rough-in opening of 10³/₄"x9¹/₄".

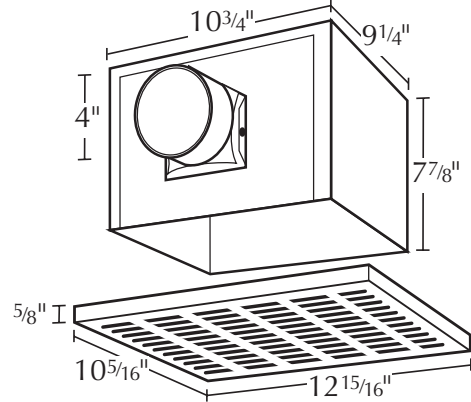

- **Damper**
Blanket - Non-asbestos, ceramic blanket
Fusible Link - Replaceable, 165°F standard
Classification - Ceiling Radiation Damper is ULC classified and rated for a 3-4 hour fire resistance. U.L. listed 555C. California State Marshall classification for 1 or 2 hour fire damper rating. California State Marshall listing number 3225-1374-101.
Contractor Pack Model: AKFD2*

* Sold in packs of 4. All three parts (housing, damper, motor/blade/grill) must be purchased and used together to make a complete unit.



Air King Ventilation Products certifies that the models shown herein are licensed to bear the AMCA seal. The ratings shown are based on tests and procedures performed in accordance with AMCA Publication 211 and AMCA Publication 311 and comply with the requirements of the Certified Ratings Program.



AMCA LICENSED PERFORMANCE											
	Static Pressure (inches of w.g.)								HVI Sones @ Ps .1 SP	Fan Speed RPM	Power Watts
	0	0.05	0.1	0.125	0.15	0.2	0.25	0.3			
Air Flow - CFM	101	94	90	88	86	80	70	55	2.0	1250	32
Sound - SONES	2.7	2.9	2.9	2.9	2.9	3.0	2.9	3.1			

Performance shown is for FRAK exhaust models for installation type B: Free inlet, Ducted outlet. Performance ratings include the effects of an inlet grille, ceiling radiation damper and backdraft damper in the airstream. Speed (RPM) shown is nominal. Performance is based on actual speed of test. The loudness ratings shown are loudness values in fan sones at 5 ft. (1.5m) in a hemispherical free field calculated per AMCA standard 301. Values shown are for installation type B: free inlet fan sone levels. The AMCA Certified Ratings Seal does not apply to HVI Sones.

PROJECT					ARCHITECT						
LOCATION					ENGINEER						
CONTRACTOR					SUBMITTED BY					DATE	
FAN NUMBER	MODEL NUMBER	CFM	IN W.G.	RPM	WATTS	AMPS	SONES	QTY	OPTIONAL EQUIPMENT & REMARKS		