

Germ Guardian Digital Humidifier

USE & CARE INSTRUCTIONS

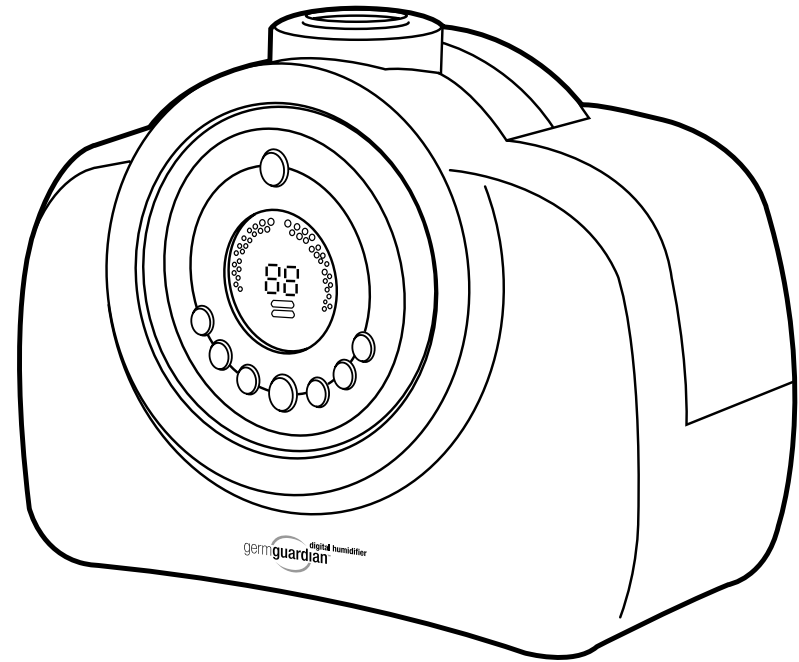

PRODUCT SPECIFICATIONS AND PARTS

SPECIFICATIONS

Model Number: H-3000
 Humidifying Mode: Combination (heating & ultrasonic)
 Power Supply: AC110V, 60Hz
 Power Consumption: 140W (40W at cold humidification)
 Maximum humidity capacity: About 350cc/Hr. (at highest setting and warm humidification)
 Tank Capacity: 1.4 Gallons
 Successive Humidity Hours: Approximately 15 hours at highest setting and warm humidification, 24 hours at lowest setting and cold humidification.
 Dimensions: Width-14.5 inches; Length-9 inches; Height-12 inches
 Weight: 6 Pounds (not including packaging)

PARTS

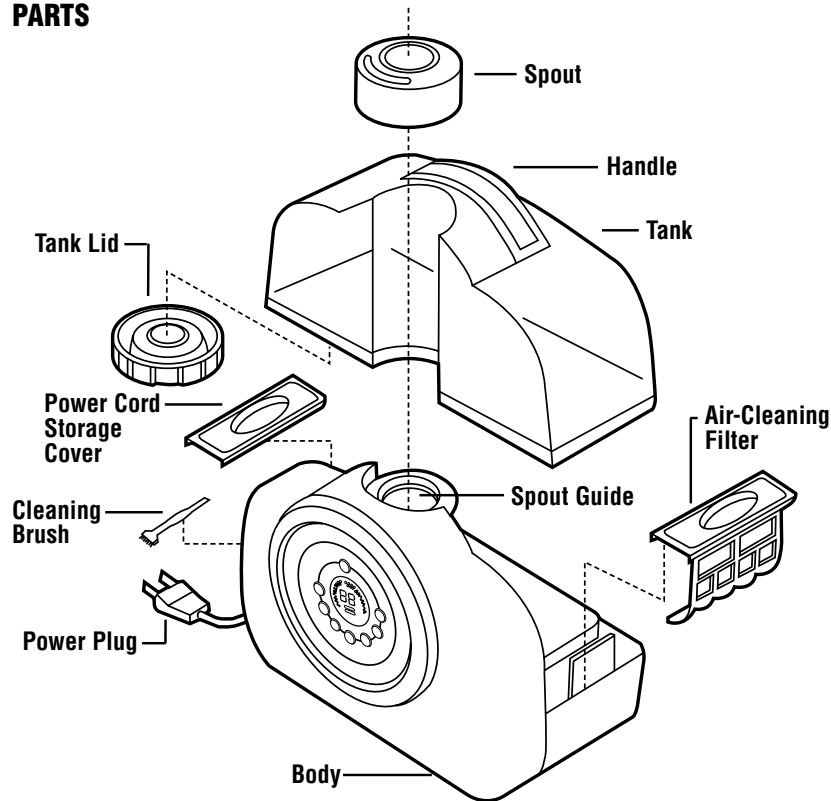

PRODUCT SPECIFICATIONS AND PARTS (cont)

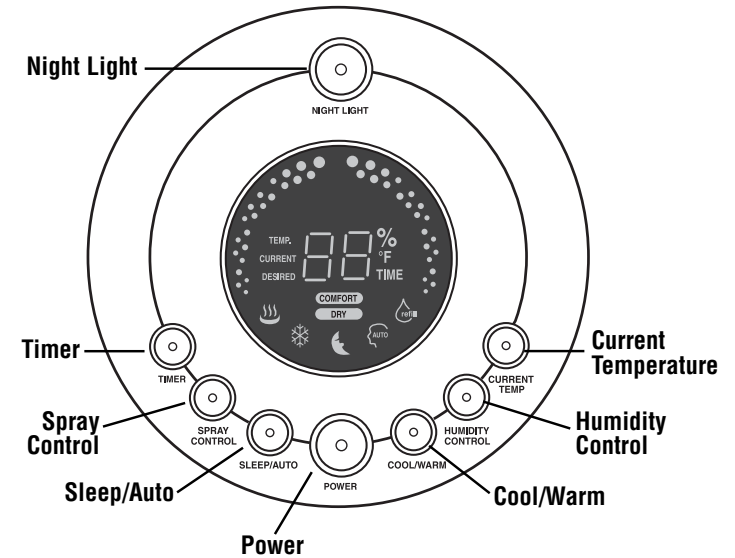

FUNCTIONS AND FEATURES

Warm or Cold Humidification Selection

Select humidifying temperature based on need. For cold humidification, water temperature is maintained at about 40 degrees. For warm humidification, it is maintained at 80 degrees to disinfect low temperature bacteria. Warm humidity will use more power but will humidify your room quicker.

Humidity Level

55%-65% Humidity is considered within the comfortable range.

Water Shortage Indicator

When the unit is low on water the Refill LED on the front panel will light up, and the unit will shut off. Simply add more water to continue use.

Humidity Adjustment

The humidity volume may be adjusted based on need by pressing the humidity control button on the front panel.

Power Cord Storage

A convenient compartment to hold the power cord makes storage easy.

WARNINGS



This product should be used only in accordance with the specifications outlined in this manual. Usage other than what has been specified here may result in serious injury.

WARNING: THE CORDS, WIRES, AND/OR CABLES SUPPLIED WITH THIS PRODUCT CONTAINS CHEMICALS, INCLUDING LEAD OR LEAD COMPOUNDS, KNOWN TO THE STATE OF CALIFORNIA TO CAUSE CANCER AND BIRTH DEFECTS OR OTHER REPRODUCTIVE HARM, WASH HANDS AFTER USING.

- Disassembly, repair or remodeling by an unauthorized person may result in serious harm.
- Do not use if plug is damaged or loose.
- Keep this product out of the reach of children.
- Be careful not to put water in the humidity spout.
- Before filling or cleaning the unit, make sure it is unplugged.
- Once the humidifier has been turned on, do not move it.
- Do not remove the bucket from the unit while it is on.
- Do not handle the plug with wet hands.
- Do not excessively bend, twist or pull the power cord.
- Avoid placing this product where the humidity is pointed directly at an electrical object.
- Do not directly inhale the humidity.
- Do not place this product on a sloped or unstable surface.
- When not in use, unplug the unit.
- Do not fill the bucket with hot or boiling water.
- Do not use this product in direct sunlight, or near a gas stove or heater.
- If the bucket becomes cracked or damaged, do not use.
- Do not clean the unit or bucket with detergents or chemicals of any kind.
- Do not use this product near any other electronic device.
- Do not cover the humidity opening at any time during use.
- Do not use this product near a sink.
- Do not place this product on an absorbent surface.

Failure to comply with the warnings listed above may result in electric shock or serious injury.

DIRECTIONS FOR USE

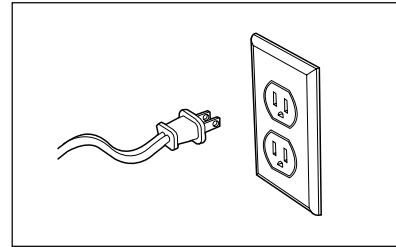

1. Unplug the unit from the wall socket.

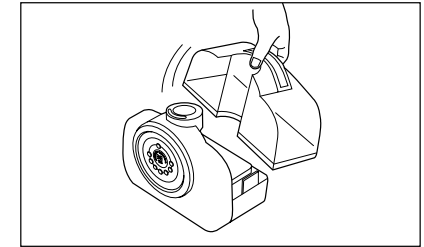

2. Separate the tank from the body of the unit.

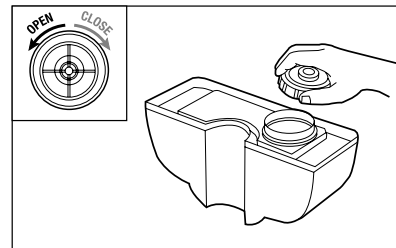

3. Open the tank lid, turning it to the left.

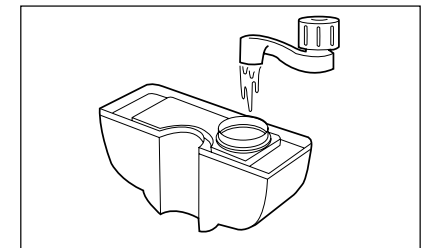

4. Pour cool, clean water directly into the tank.

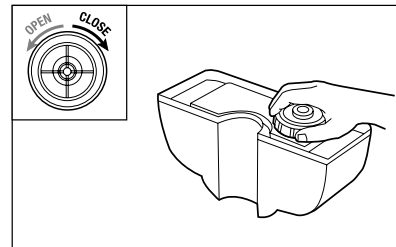

5. Close the tank lid, turning it to the right.

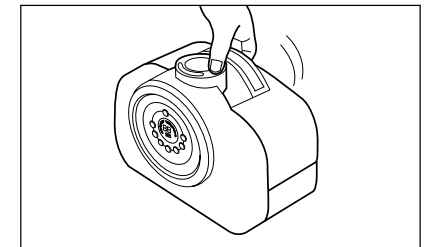

6. Attach the tank to the body of the unit.

DIRECTIONS FOR USE (cont)

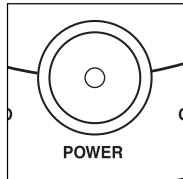

7. Power Button

Before turning on make sure there is water in the unit. Press the Power Button.

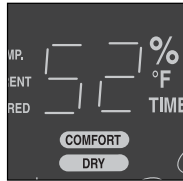

8. The current humidity level in the room will be shown on the display. The humidity reading will not display below 35%.

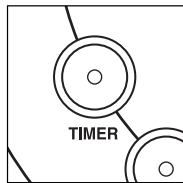

9. Timer Button

Press the Timer button and set the number of hours you would like your Germ Guardian™ Ultrasonic Humidifier to run (1-hour, 2-hours up to 12 hours).
 · If you press the button during operation the remaining time is displayed.
 · Press it again to adjust the time.
 Co - means Constant Humidification.

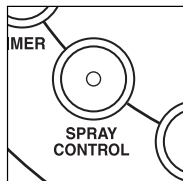

10. Humidity Control Button

When you press the Humidity Control Button there are four options to choose from:

- Press once for weak
- Press twice for middle
- Press three times for strong
- Press four times for turbo

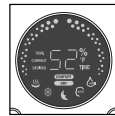

* You will notice the lights get higher as the spray increases.

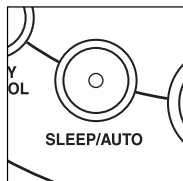

11. Auto

Press once for auto. This will adjust the humidity setting to 80% humidity - warm humidification!

Sleep

Press twice to activate sleep mode. This will turn on the moon icon and turn off all other display lights.

DIRECTIONS FOR USE (cont)

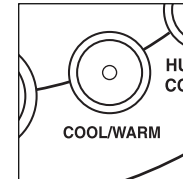

12. Press to select cold or warm humidification. Water temperature is maintained at 40 degrees for cold and 80 degrees for warm.

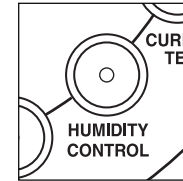

13. Press the Humidity Control Button to change the humidity level.
 · Humidity level options include: 50%, 55%, 60%, 65%, 70%, 75%, 80%.
 · Five seconds after pressing this button the current humidity level will be displayed.
 This will not affect the spray output!
 Co - means Constant Humidification.



14. Water Refill Button

When the Water Refill Button lights up it is time to refill the water tank.

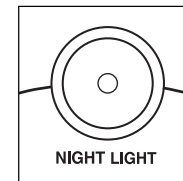

15. Night Light Button

Press the night light button at the top of the unit to illuminate the night light feature.

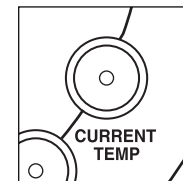

16. Press to display the current temperature in your room.

an *SefaCo.* Store
 1-800-667-8721