

SPECIFICATION SHEET

**TRANSITIONS
AND
DAMPERS**

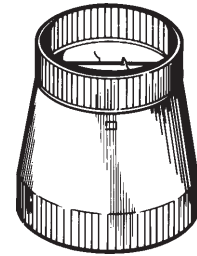

TRANSITIONS

Model 411

- 3¼" x 10" to 6" round

Model 412H

- 3¼" x 10" to 7" round

Model 413

- 3¼" x 10" to 8" round

All models above -
30 GA galvanized steel
construction

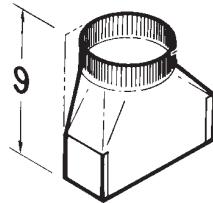

Model 423

- 4½" x 18½" to 10" round
- vertical discharge
- 26 GA galvanized steel
construction
- For use with Model 422
rough-in kit and Model
323 barbeque blower
system or 332K with
331/332 Remote Blower
or Model 326 Interior
Blower

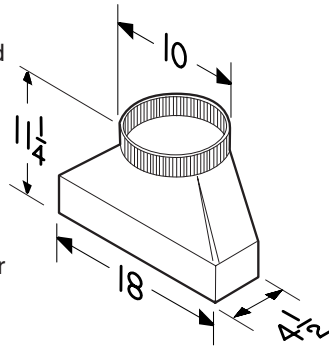

Model 424

- 4½" x 18½" to 10" round
horizontal, rear
discharge
- 26 GA galvanized steel
construction
- For use with Model 422
rough-in kit and Model
323 barbeque blower
system and 332K with
331/332 Remote Blower
and Model 326 Interior
Blower

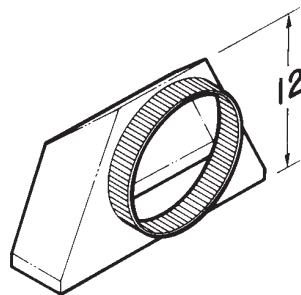

Model 453

- 4½" x 18½" to 10"
round horizontal,
left discharge
- 26 GA galvanized
steel construction
- For use with
Model 422 rough-
in kit and Model
323 barbeque
blower system
and 332K with
331/332 Remote
Blower and
Model 326
Interior Blower

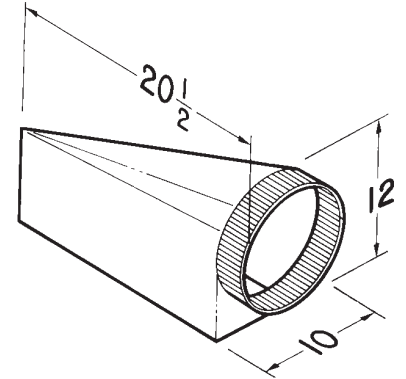

Model 454

- Same as Model
453 except -
horizontal right
discharge

Model 459

- 3¼" x 14" to 8" round -
vertical discharge
- 30 GA galvanized steel
construction
- For use with Dowlndraft
Exterior Blower Systems.

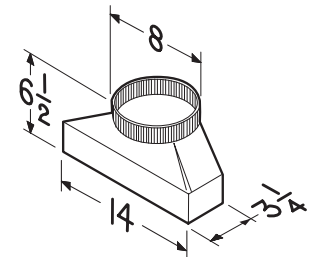

REFERENCE	QTY.	REMARKS	Project
			Location
			Architect
			Engineer
			Contractor
			Submitted by Date

DAMPERS

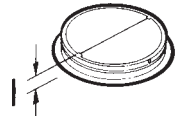

- Model BP87**
- 7" round damper
 - Extruded steel with electrically-bonded epoxy finish
 - .016 Aluminum louvers
 - For use with 42000 range hood

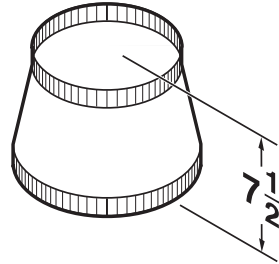

- Model 414**
- 10" round to 8" round reducer
 - Black, electrically-bonded epoxy finish
 - 24 GA galvanized steel

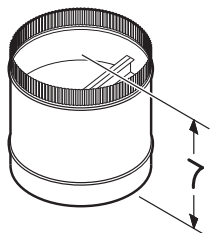

- Model 97**
- 7" round damper
 - 28 GA galvanized steel
 - Aluminum louvers

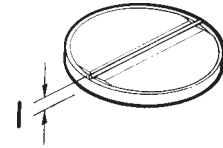

- Model 421**
- 10" round damper
 - 24 GA galvanized steel with aluminum louvers

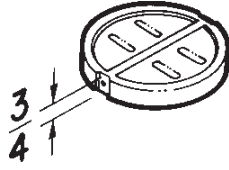

- Model 99**
- 9" round damper
 - .032 All Aluminum construction
 - Spring-loaded aluminum louvers

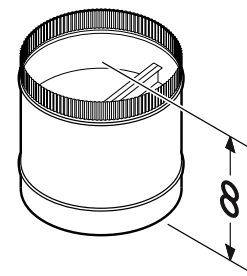

- Model 438**
- 8" round damper
 - 24 GA galvanized steel with aluminum louvers

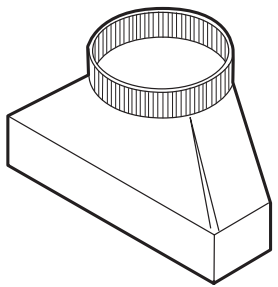

- Model T81212**
- 8" x 12" to 12" Round
 - 28 ga. galvanized steel

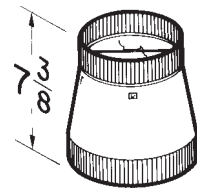

- Model 472**
- 10" round to 8" round reducer/damper
 - Black, electrically-bonded epoxy finish
 - Spring-loaded aluminum louvers
 - Rubber stops
 - 24 GA galvanized steel