

DECORATIVE SERIES CEILING VENTILATOR

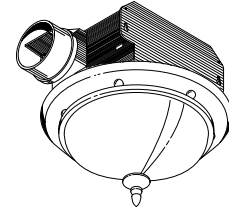

WARNING

TO REDUCE THE RISK OF FIRE, ELECTRIC SHOCK, OR INJURY TO PERSONS, OBSERVE THE FOLLOWING:

1. Use this unit only in the manner intended by the manufacturer. If you have questions, contact the manufacturer at the address or telephone number listed in the warranty.
2. Before servicing or cleaning unit, switch power off at service panel and lock the service disconnecting means to prevent power from being switched on accidentally. When the service disconnecting means cannot be locked, securely fasten a prominent warning device, such as a tag, to the service panel.
3. Installation work and electrical wiring must be done by a qualified person(s) in accordance with all applicable codes and standards, including fire-rated construction codes and standards.
4. Sufficient air is needed for proper combustion and exhausting of gases through the flue (chimney) of fuel burning equipment to prevent backdrafting. Follow the heating equipment manufacturer's guideline and safety standards such as those published by the National Fire Protection Association (NFPA), and the American Society for Heating, Refrigeration and Air Conditioning Engineers (ASHRAE), and the local code authorities.
5. When cutting or drilling into wall or ceiling, do not damage electrical wiring and other hidden utilities.
6. Ducted fans must always be vented to the outdoors.
7. NEVER place a switch where it can be reached from a tub or shower.
8. This unit must be grounded.
9. This unit is U.L. listed. Type I.C. inherently protected.

CAUTION

1. For general ventilating use only. Do not use to exhaust hazardous or explosive materials and vapors.
2. This product is designed for installation in FLAT CEILINGS ONLY. Do not mount this product in a wall.
3. The light fixture assembly must be mounted to the fan housing assembly included with this product. Do not mount the light fixture assembly to a wiring outlet box.
4. To avoid motor bearing damage and noisy and/or unbalanced impellers, keep drywall spray, construction dust, etc. off power unit.
5. Please read specification label on product for further information and requirements.

TYPICAL INSTALLATIONS

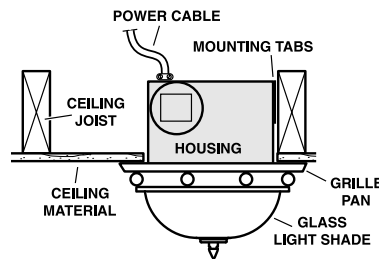

**HOUSING MOUNTED
DIRECTLY TO JOIST
2x6 (or larger)**
Discharge parallel to joists.

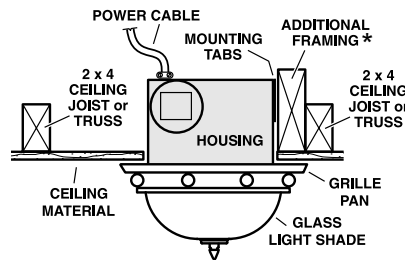

**HOUSING MOUNTED
TO 2x4 TRUSS**
*Requires additional framing
for mounting tabs.*
Discharge parallel to joists.

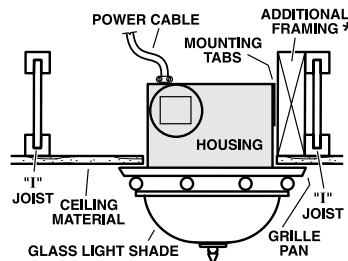

HOUSING MOUNTED TO "1" JOIST
*Requires additional framing
for mounting tabs.*
Discharge parallel to joists.

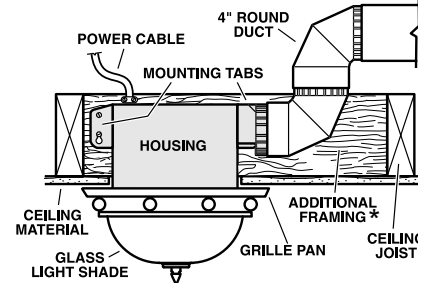

**HOUSING MOUNTED
TO ADDITIONAL FRAMING**
Discharge 90° to joists.

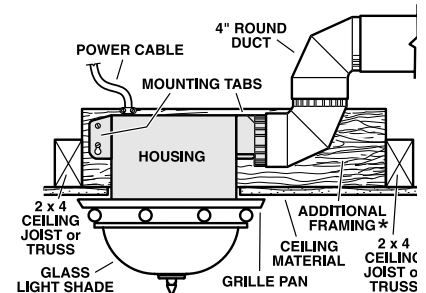

**HOUSING MOUNTED TO 2x4
TRUSS**
*Requires additional framing
for mounting tabs.*
Discharge 90° to joists.

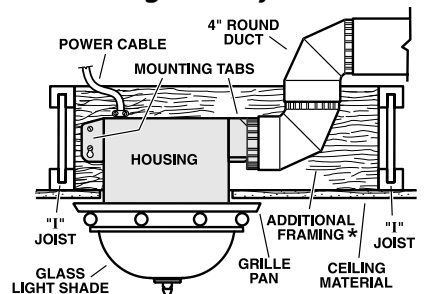

HOUSING MOUNTED TO "1" JOIST
*Requires additional framing
for mounting tabs.*
Discharge 90° to joists.

* Additional framing must be a 2x6 (minimum height), at least 9-inches long.

TYPICAL INSTALLATIONS (continued)

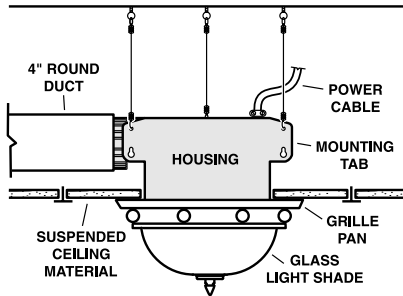

SUSPENDED CEILINGS

Housing hung with wires - 3-point mount.

INSTALL THE HOUSING

- PLEASE NOTE -

THE FOLLOWING INSTALLATION ILLUSTRATIONS SHOW 2 X 6 JOISTS. IF YOU HAVE A TRUSS OR "I"-JOIST INSTALLATION, MOUNT THE VENTILATOR TO THE ADDITIONAL FRAMING IN THE SAME MANNER. (Additional framing must be a 2x6 (minimum height), at least 9-inches long.)

New Construction

1. Choose the location for your fan in the ceiling. For best possible performance, use the shortest possible duct run and a minimum number of elbows.

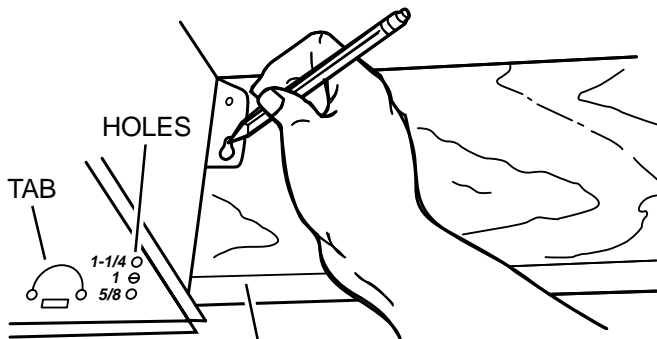

BOTTOM EDGE OF JOIST

2. Position mounting brackets against joist so that bottom edge of housing will be flush with finished ceiling.

Additional positioning feature for 5/8", 1", & 1-1/4" thick ceiling material:

Holes in corners of housing are labeled with various ceiling material thicknesses. Position housing so bottom edge of joist is visible through a matched set of holes. The housing is now in the proper position for that ceiling material thickness.

Additional positioning feature for 1/2" thick ceiling material:

Bend two tabs, on side of housing, 90° outward. Lift housing until tabs contact underside of joist.

Mark the keyhole slot on both mounting brackets.

INSTALL THE HOUSING (continued)

New Construction

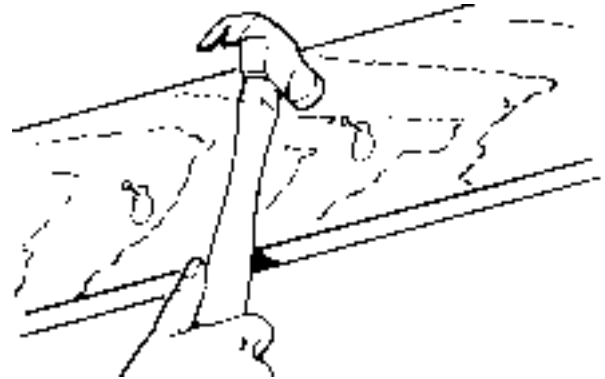

3. Set housing aside and drive nails partially into joist at the top of both keyhole marks.

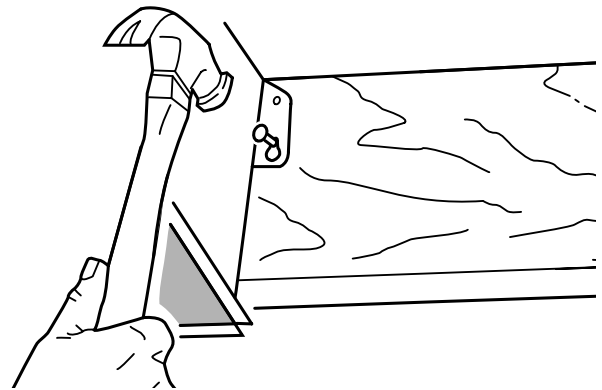

4. Hang housing from nails and pound nails tight. To ensure a noise-free mount, pound another nail through the top hole of each mounting tab.

Existing Construction

1. Choose the location for your fan/light in the ceiling. For best possible performance, use the shortest possible duct run and a minimum number of elbows.

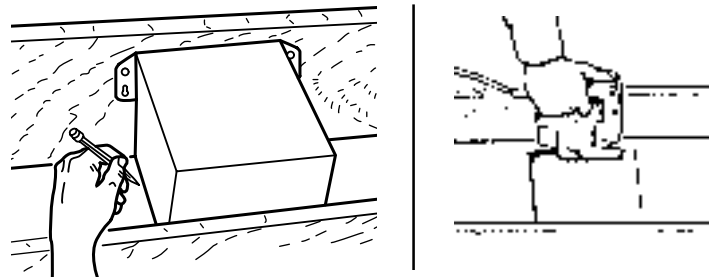

2. In attic, position mounting brackets against joist. Trace outline of housing on ceiling material.
3. Set housing aside and cut ceiling opening slightly larger than marked.

INSTALL THE HOUSING (continued)

Existing Construction

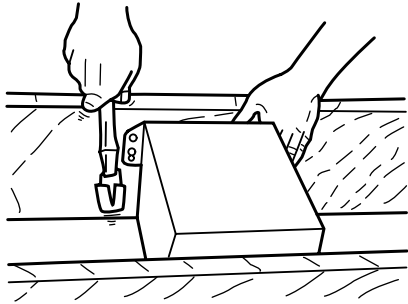

- Place housing in opening so that its bottom edge is flush with finished ceiling. Nail to joist through keyhole on both sides. To ensure a noise-free installation, drive another nail through the top hole of each mounting bracket.

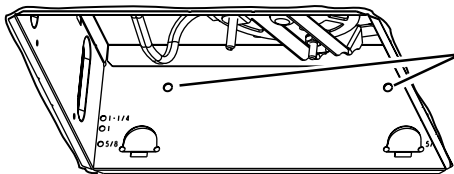

ADDITIONAL MOUNTING HOLES

- Additional mounting holes are provided for installations where access from above is inconvenient or not possible. Nail or screw housing directly to joists or framing.

INSTALL THE DUCTWORK

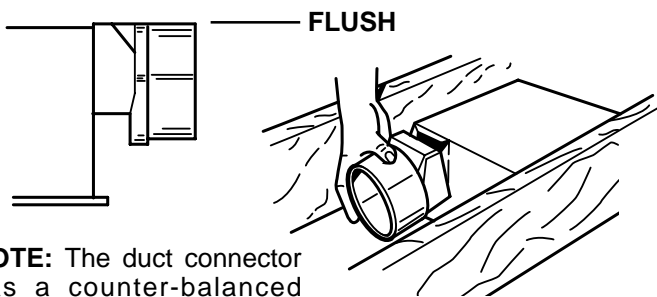

NOTE: The duct connector has a counter-balanced damper flap. The flap will be "open" approx. 1" when duct connector is attached to housing. This design permits insulation to be in direct contact with fan/light housing per UL (Underwriters Laboratories) standards. The slightest backdraft, however, will close the damper flap, preventing air from entering unit or finished space.

- Snap the damper/duct connector onto housing. Make sure that tabs on the connector lock into slots in housing. Top of damper/duct connector should be flush with top of housing.
- Connect 4" round duct to damper/duct connector and extend duct to outside through a roof or wall cap. Check damper to make sure that it opens freely. Tape all duct connections to make them secure and air tight.

CONNECT THE WIRING

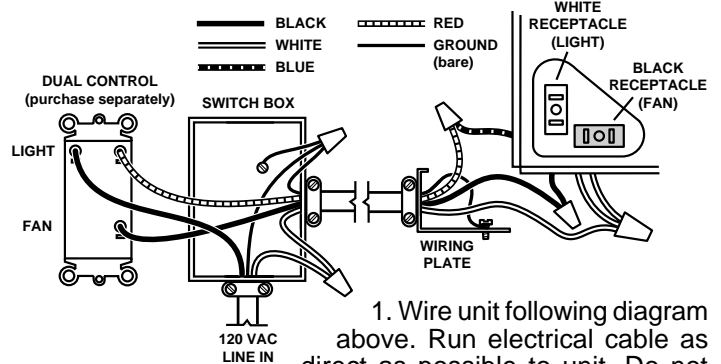
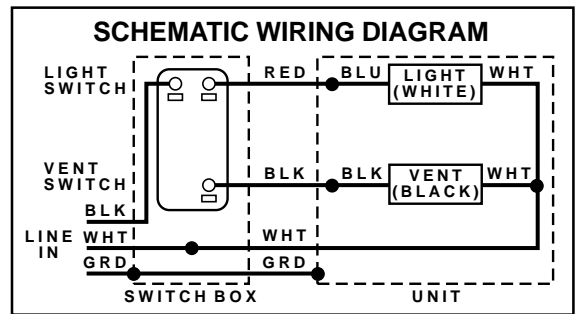

- Wire unit following diagram above. Run electrical cable as direct as possible to unit. Do not allow cable to touch sides or top of unit after installation is complete.

ATTACH THE GRILLE PAN AND GLASS SHADE

- Locate the grille pan over the fan housing and connect the wiring harness plug into white receptacle in the fan housing.

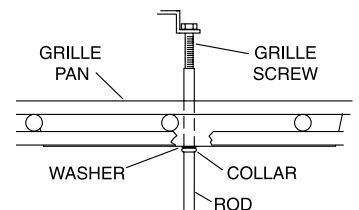

- Insert rod through center hole of grille pan. Use washer between collar on rod and pan.
- Thread rod onto grille screw in housing, until pan is tight against ceiling.
- Install bulbs. Use 60 Watt (maximum), candelabra base bulbs.

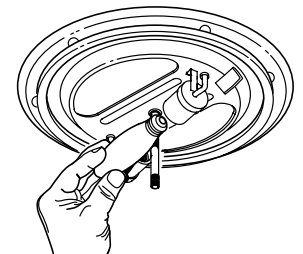

- Place glass shade over mounting rod and align shade onto grille pan. Secure glass shade to grille pan with finial cap and finial nut as shown.
- Restore electrical power and check operation of the unit.

